



## High Purity Fittings & Connectors



### FITTING MATERIALS AVAILABLE

- PTFE
- PFA
- PVDF

### TUBE FITTINGS

Barbed Fitting  
Bulkhead Female Connector  
Bulkhead Male Connector  
Bulkhead Union  
Female Branch Tee  
Female Connector  
Female Elbow  
Female Run Tee  
Male Branch Tee  
Male Connector  
Male Elbow  
Male Run Tee  
Reducing Union  
Tube Cap  
Tube Insert  
Union  
Union Cross  
Union Elbow  
Union Elbow Reducer  
Union Tee

### THREE COMPRESSION NUT MATERIAL TYPES

- HA - Injection Molded PVDF Nut\*\* (Standard Configuration)
- TA - PTFE Nut with Anodized Aluminum Support Band
- TS - PTFE Nut with Stainless Support Band

### FLARED FITTINGS

Male Connector  
Female Connector  
Union Elbow  
Union Elbow Reducer  
Union Tee  
Male Run Tee  
Male Branch Tee  
Bulkhead Union  
Bulkhead Male Connector  
Bulkhead Union Reducer  
Union  
Union Reducer  
Male Elbow  
Flare Caps

### PIPE FITTINGS

Bushing  
Coupling  
Elbow  
Female Reducer  
Pipe Nipple  
Pipe Union  
Plug  
Tee

### SPARES

Ferrule\*\*  
Nut  
Panel Nut

### MINI FITTINGS

Nut  
Ferrule  
Insertion Tool

\*\*All HA style fittings are standard equipped with a PTFE ferrule & Kynar Gripper.



# SPECIFICATIONS: Tube Fitting Assembly

## Pressure Ratings:

- Performance at ambient room conditions: 120 psi for 1/16" fittings linear decreasing to 80 psi for 3/4" fittings and 60 psi for fittings larger than 3/4".
- Performance at elevated temperatures up to 85°C/185°F: 90 psi for 1/16" fittings linear decreasing to 60 psi for 3/4" fittings and 40 psi for fittings larger than 3/4".
- Contact factory for temperature ratings above 85°C / 185°F.
- Temperature below 72° F the pressure rating does not increase or decrease. Pressure rating is maintained from 72° F and below.
- See page 23 for further details

## Materials of Construction

- Fittings: Machined from virgin Polytetrafluoroethylene (PTFE).
- Ferrules: Ferrules are machined from virgin Polytetrafluoroethylene (PTFE).
- Grippers: The Gripper in the two piece Ferrule-Gripper assemblies are manufactured from PVDF.
- Nuts: The "HA" style nuts are molded PVDF.

Pressure performance ratings are based on laboratory testing, industry standard material characteristics and historical data. A combination of extreme temperature and pressure may affect these products. The user is responsible for verifying the suitability of these products for their application.

## FERRULE & GRIPPER STYLE

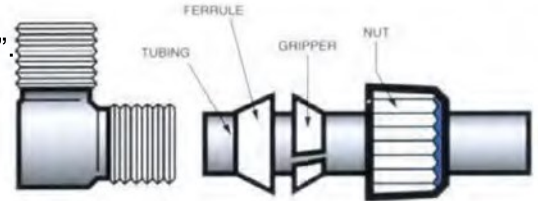

1. Cut tubing to desired length.
2. Loosen the nut, insert tube.
3. Tighten the nut finger tight.
4. The fitting is ready to use.

## FLARED END STYLE

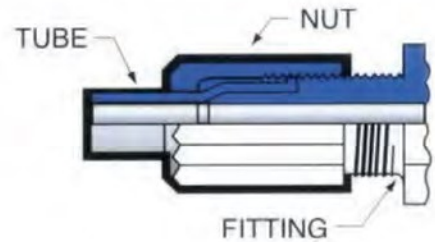

## ORDERING FORMAT

**MC - F - 8 6**

### Indicates Connection Size

Tube O.D., FNPT, MNPT, or Flared I.D.  
 Example: 6 = 6/16" (3/8"), O.D.  
 6 = 6mm Tube O.D.  
 6 = 3/8 Flared I.D.

### Indicates Connection Size

Tube O.D., FNPT, MNPT, or Flared I.D.  
 Example: 6 = 6/16" (3/8"), O.D.  
 6 = 6mm Tube O.D.  
 6 = 3/8 Flared I.D.

**Tube O.D or Flare O.D is Listed Before NPT Size**

### Indicates Fitting Category

F = Fractional Size Tube Fitting  
 M = Metric Size Tube Fitting  
 P = Pipe Fitting  
 FF = Fractional Flared

### Indicates Type of Fitting

Example: MC-F-86 = Male Connector  
 Fractional Size to connect 1/2" O.D Tubing to 3/8" MNPT,  
 PVDF Nut

### Note:

Exceptions to above ordering procedure  
 Barbed Fittings  
 Bugle Fittings  
 Mini Fittings



# iPolymer TUBE FITTINGS

## Barbed Fitting

101660

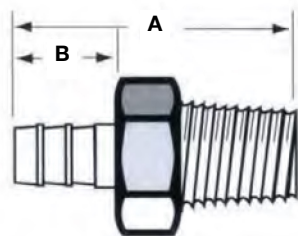

Part #	Hose I.D.	Male Pipe	A Dim.	B Dim.
BF-F-12	1/16"	1/8" NPT	.99	.38
BF-F-22	1/8"	1/8" NPT	.99	.38
BF-F-32	3/16"	1/8" NPT	1.13	.50
BF-F-34	3/16"	1/4" NPT	1.44	.50
BF-F-36	3/16"	3/8" NPT	1.44	.50
BF-F-54	5/16"	1/4" NPT	1.56	.63
BF-F-56	5/16"	3/8" NPT	1.56	.63
BF-F-58	5/16"	1/2" NPT	1.88	.63
BF-F-64	3/8"	1/4" NPT	1.44	.50
BF-F-66	3/8"	3/8" NPT	1.44	.50
BF-F-68	3/8"	1/2" NPT	1.75	.50
BF-F-74	7/16"	3/8" NPT	1.69	.75
BF-F-76	7/16"	3/8" NPT	1.69	.75
BF-F-78	7/16"	1/2" NPT	2.00	.75
BF-F-712	7/16"	3/4" NPT	2.00	.75
BF-F-1112	11/16"	3/4" NPT	2.13	.88
BF-F-1116	11/16"	1" NPT	2.32	.88
BF-F-1616	1"	1" NPT	2.44	1.00

## Bulkhead Female Connector

101772

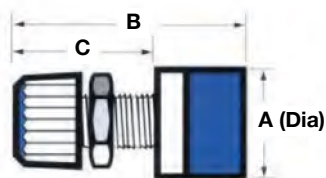

Part #	Tube O.D.	FNPT	Panel Hole (Drill Size)	A Dim.	B Dim.	C Dim.
BFC-F-22	1/8"	1/8" NPT	21/64	.75	1.51	.88
BFC-F-32	3/16"	1/8" NPT	25/64	.75	1.51	.88
BFC-F-42	1/4"	1/8" NPT	29/64	.75	1.70	.94
BFC-F-44	1/4"	1/4" NPT	29/64	.84	1.88	.94
BFC-F-54	5/16"	1/4" NPT	37/64	.84	1.88	.94
BFC-F-56	5/16"	3/8" NPT	37/64	1.00	1.88	.94
BFC-F-66	3/8"	3/8" NPT	45/64	1.00	1.94	1.00
BFC-F-88	1/2"	1/2" NPT	57/64	1.25	2.44	1.19
BFC-F-1616	1"	1" NPT	11/64	1.75	2.94	1.50
BFC-M-42	4mm	1/8" NPT	25/64	.75	1.38	.75
BFC-M-62	6mm	1/8" NPT	29/64	.75	1.70	.94
BFC-M-64	6mm	1/4" NPT	29/64	.84	1.88	.94
BFC-M-84	8mm	1/4" NPT	37/64	.84	1.88	.94
BFC-M-104	10mm	1/4" NPT	45/64	.84	1.94	1.00
BFC-M-106	10mm	3/8" NPT	45/64	1.00	1.94	1.00

Call iPolymer with your special application requirements.  
We manufacture short-run custom machined PTFE and PVDF Fittings.

### iPolymer Product Notes:

1. Please email Customer Service at [info@ipolymer.com](mailto:info@ipolymer.com)
2. Call us for special applications. We can manufacture our Fittings with special mounting and interface dimensions.
3. Upon request, alternate material selection from those listed will allow for expanding temperature ratings or other performance characteristics.
4. Unauthorized disassembly of this product will void the original factory one-year product warranty. For further details please contact your local Distributor or our factory directly.

200304

international polymer solutions inc. • manufacturer of high purity fluid handling products  
[www.ipolymer.com](http://www.ipolymer.com) • [info@ipolymer.com](mailto:info@ipolymer.com)

Part #	Tube O.D.	Male Pipe	Panel Hole (Drill Size)	A Dim.	B Dim.	C Dim.
BMC-F-22	1/8"	1/8 NPT	21/64	1.51	.88	.44
BMC-F-32	3/16"	1/8 NPT	25/64	1.51	.88	.44
BMC-F-42	1/4"	1/8 NPT	29/64	1.57	.94	.56
BMC-F-44	1/4"	1/4 NPT	29/64	1.88	.94	.56
BMC-F-54	5/16"	1/4 NPT	37/64	1.88	.94	.75
BMC-F-56	5/16"	3/8 NPT	37/64	1.88	.94	.75
BMC-F-64	3/8"	1/4 NPT	45/64	1.94	1.00	.75
BMC-F-66	3/8"	3/8 NPT	45/64	1.94	1.00	.75
BMC-F-88	1/2"	1/2 NPT	57/64	2.38	1.13	.94
BMC-F-1616	1"	1" NPT	11/64	2.94	1.50	1.50
BMC-M-42	4mm	1/8 NPT	25/64	1.51	.88	.44
BMC-M-62	6mm	1/8 NPT	29/64	1.59	.94	.56
BMC-M-64	6mm	1/4 NPT	29/64	1.88	.94	.56
BMC-M-84	8mm	1/4 NPT	37/64	1.88	.94	.75
BMC-M-104	10mm	1/4 NPT	45/64	1.94	1.00	.75
BMC-M-106	10mm	3/8 NPT	45/64	1.94	1.00	.75

## Bulkhead Male Connector

101788

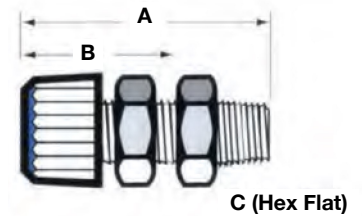

NOTE: For 1/4" max. panel thickness

Part #	Tube O.D.	Panel Hole (Drill Size)	A Dim.	B Dim.	C Dim.
BU-F-2	1/8"	21/64	1.51	.88	.44
BU-F-3	3/16"	25/64	1.51	.88	.44
BU-F-4	1/4"	29/64	1.81	.94	.56
BU-F-5	5/16"	37/64	1.81	.94	.75
BU-F-6	3/8"	45/64	1.81	.94	.75
BU-F-8	1/2"	57/64	2.25	1.19	.94
BU-F-10	5/8"	1-1/64	2.33	1.23	1.13
BU-F-12	3/4"	1-9/64	2.38	1.25	1.13
BU-F-16	1"	1-25/64	2.53	1.33	1.50
BU-F-11	1.1"	1-1/2	2.62	1.44	1.59
BU-M-4	4mm	25/64	1.51	.88	.44
BU-M-6	6mm	29/64	1.81	.94	.56
BU-M-8	8mm	37/64	1.81	.94	.75
BU-M-10	10mm	45/64	1.81	.94	.75
BU-M-12	12mm	57/64	2.25	1.19	.94

## Bulkhead Union

101004

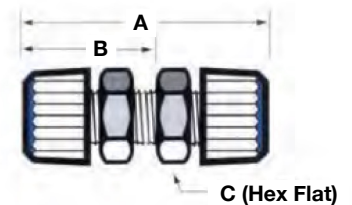

Part #	Tube O.D.	Female Pipe	A Dim.	B Dim.
FBT-F-22	1/8"	1/8 NPT	1.39	1.01
FBT-F-32	3/16"	1/8 NPT	1.39	1.01
FBT-F-42	1/4"	1/8 NPT	1.63	1.01
FBT-F-44	1/4"	1/4 NPT	1.75	1.31
FBT-F-64	3/8"	1/4 NPT	1.75	1.31
FBT-F-66	3/8"	3/8 NPT	1.88	1.44
FBT-F-68	3/8"	1/2 NPT	2.13	1.88
FBT-F-86	1/2"	3/8 NPT	2.12	1.56
FBT-F-88	1/2"	1/2 NPT	2.25	1.88
FBT-F-108	5/8"	1/2 NPT	2.33	1.88
FBT-F-1212	3/4"	3/4 NPT	2.62	2.13
FBT-F-1616	1"	1" NPT	2.90	2.44
FBT-M-42	4mm	1/8 NPT	1.39	1.01
FBT-M-62	6mm	1/8 NPT	1.63	1.01
FBT-M-64	6mm	1/4 NPT	1.75	1.31
FBT-M-84	8mm	1/4 NPT	1.75	1.31
FBT-M-104	10mm	1/4 NPT	1.75	1.31
FBT-M-106	10mm	3/8 NPT	1.88	1.44

## Female Branch Tee

101612

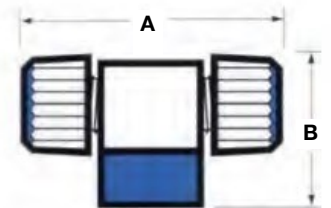

# iPolymer TUBE FITTINGS

## Female Connector

101619

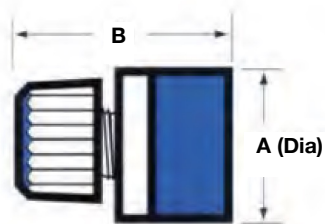

Part #	Tube O.D.	Female Pipe	A Dim.	B Dim.
FC-F-22	1/8"	1/8" NPT	.75	1.14
FC-F-24	1/8"	1/4" NPT	.84	1.32
FC-F-32	3/16"	1/8" NPT	.75	1.14
FC-F-42	1/4"	1/8" NPT	.75	1.26
FC-F-44	1/4"	1/4" NPT	.84	1.44
FC-F-46	1/4"	3/8" NPT	1.00	1.44
FC-F-66	3/8"	3/8" NPT	1.00	1.44
FC-F-84	1/2"	1/4" NPT	.875	1.62
FC-F-86	1/2"	3/8" NPT	1.00	1.62
FC-F-88	1/2"	1/2" NPT	1.25	1.81
FC-F-124	3/4"	1/4" NPT	1.13	1.68
FC-F-128	3/4"	1/2" NPT	1.13	1.87
FC-F-1212	3/4"	3/4" NPT	1.50	1.87
FC-F-1616	1"	1" NPT	1.75	2.14
FC-M-42	4mm	1/8" NPT	.75	1.14
FC-M-62	6mm	1/8" NPT	.75	1.26
FC-M-64	6mm	1/4" NPT	.84	1.44
FC-M-84	8mm	1/4" NPT	.84	1.44
FC-M-104	10mm	1/4" NPT	.84	1.44
FC-M-106	10mm	3/8" NPT	1.00	1.44
FC-M-128	12mm	1/2" NPT	1.25	1.81

## Female Elbow

101611

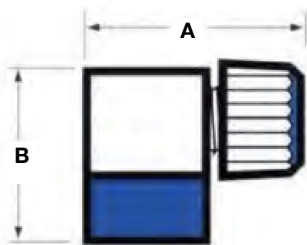

Part #	Tube O.D.	Female Pipe	A Dim.	B Dim.
FE-F-22	1/8"	1/8" NPT	1.01	1.01
FE-F-32	3/16"	1/8" NPT	1.01	1.01
FE-F-42	1/4"	1/8" NPT	1.13	1.13
FE-F-44	1/4"	1/4" NPT	1.31	1.31
FE-F-64	3/8"	1/4" NPT	1.31	1.31
FE-F-66	3/8"	3/8" NPT	1.44	1.44
FE-F-68	3/8"	1/2" NPT	1.88	1.88
FE-F-86	1/2"	3/8" NPT	1.56	1.56
FE-F-88	1/2"	1/2" NPT	1.88	1.88
FE-F-108	5/8"	1/2" NPT	1.88	1.88
FE-F-128	3/4"	1/2" NPT	2.00	2.00
FE-F-1212	3/4"	3/4" NPT	2.13	2.13
FE-F-1616	1"	1" NPT	2.44	2.44
FE-M-42	4mm	1/8" NPT	1.01	1.01
FE-M-62	6mm	1/8" NPT	1.13	1.13
FE-M-64	6mm	1/4" NPT	1.31	1.31
FE-M-84	8mm	1/4" NPT	1.31	1.31
FE-M-104	10mm	1/4" NPT	1.31	1.31
FE-M-106	10mm	3/8" NPT	1.44	1.44

## Female Run Tee

101003

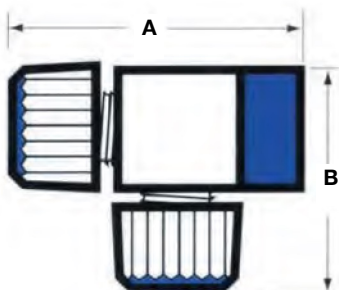

Part #	Tube O.D.	Female Pipe	A Dim.	B Dim.
FRT-F-22	1/8"	1/8" NPT	1.39	1.01
FRT-F-32	3/16"	1/8" NPT	1.39	1.01
FRT-F-42	1/4"	1/8" NPT	1.50	1.13
FRT-F-44	1/4"	1/4" NPT	1.81	1.25
FRT-F-52	5/16"	1/8" NPT	1.50	1.13
FRT-F-64	3/8"	1/4" NPT	1.81	1.25
FRT-F-86	1/2"	3/8" NPT	2.13	1.56
FRT-F-88	1/2"	1/2" NPT	2.44	1.73
FRT-F-108	5/8"	1/2" NPT	2.48	1.73
FRT-F-1212	3/4"	3/4" NPT	2.75	2.00
FRT-F-1616	1"	1" NPT	3.14	2.20
FRT-M-42	4mm	1/8" NPT	1.38	1.00
FRT-M-62	6mm	1/8" NPT	1.50	1.13
FRT-M-64	6mm	1/4" NPT	1.81	1.25
FRT-M-84	8mm	1/4" NPT	1.81	1.25
FRT-M-104	10mm	1/4" NPT	1.81	1.25
FRT-M-106	10mm	3/8" NPT	1.94	1.38

Part #	Tube O.D.	Male Pipe	A Dim.	B Dim.
MBT-F-22	1/8"	1/8" NPT	1.20	1.01
MBT-F-24	1/8"	1/4" NPT	1.32	1.31
MBT-F-32	3/16"	1/8" NPT	1.20	1.01
MBT-F-42	1/4"	1/8" NPT	1.56	1.13
MBT-F-44	1/4"	1/4" NPT	1.56	1.13
MBT-F-46	1/4"	3/8" NPT	1.75	1.50
MBT-F-64	3/8"	1/4" NPT	1.75	1.50
MBT-F-66	3/8"	3/8" NPT	1.75	1.50
MBT-F-68	3/8"	1/2" NPT	2.00	1.94
MBT-F-86	1/2"	3/8" NPT	2.13	1.75
MBT-F-88	1/2"	1/2" NPT	2.12	1.94
MBT-F-108	5/8"	1/2" NPT	2.33	2.06
MBT-F-1212	3/4"	3/4" NPT	2.50	2.19
MBT-F-1616	1"	1" NPT	2.90	2.75
MBT-M-42	4mm	1/8" NPT	1.20	1.01
MBT-M-62	6mm	1/8" NPT	1.56	1.13
MBT-M-64	6mm	1/4" NPT	1.56	1.31
MBT-M-84	8mm	1/4" NPT	1.75	1.50
MBT-M-104	10mm	1/4" NPT	1.75	1.50
MBT-M-106	10mm	3/8" NPT	1.75	1.50

## Male Branch Tee

101613

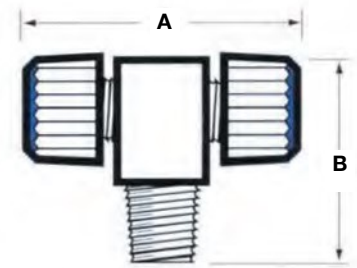

Part #	Tube O.D.	Male Pipe	A Dim.	B Dim.
MC-F-12	1/16"	1/8" NPT	1.01	.44
MC-F-21	1/8"	1/16" NPT	1.01	.44
MC-F-22	1/8"	1/8" NPT	1.01	.44
MC-F-24	1/8"	1/4" NPT	1.32	.56
MC-F-32	3/16"	1/8" NPT	1.01	.44
MC-F-41	1/4"	1/16" NPT	1.26	.56
MC-F-42	1/4"	1/8" NPT	1.26	.56
MC-F-44	1/4"	1/4" NPT	1.44	.56
MC-F-46	1/4"	3/8" NPT	1.44	.75
MC-F-48	1/4"	1/2" NPT	1.75	.94
MC-F-52	5/16"	1/8" NPT	1.26	.75
MC-F-54	5/16"	1/4" NPT	1.44	.75
MC-F-56	5/16"	3/8" NPT	1.44	.75
MC-F-64	3/8"	1/4" NPT	1.56	.75
MC-F-66	3/8"	3/8" NPT	1.56	.75
MC-F-68	3/8"	1/2" NPT	1.75	.94
MC-F-84	1/2"	1/4" NPT	1.62	.94
MC-F-86	1/2"	3/8" NPT	1.62	.94
MC-F-88	1/2"	1/2" NPT	1.81	.94
MC-F-108	5/8"	1/2" NPT	1.85	1.13
MC-F-1212	3/4"	3/4" NPT	1.87	1.25
MC-F-1612	1"	3/4" NPT	1.95	1.50
MC-F-1616	1"	1" NPT	2.14	1.50
MC-M-42	4mm	1/8" NPT	1.01	.44
MC-M-62	6mm	1/8" NPT	1.26	.56
MC-M-64	6mm	1/4" NPT	1.44	.56
MC-M-84	8mm	1/4" NPT	1.44	.75
MC-M-104	10mm	1/4" NPT	1.44	.75
MC-M-106	10mm	3/8" NPT	1.44	.75
MC-M-126	12mm	3/8" NPT	1.62	.94
MC-M-128	12mm	1/2" NPT	1.81	.94

## Male Connector

101008

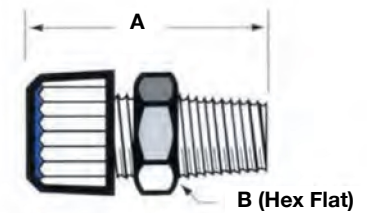

The Bore-Through ("BT") option is available for Male Connectors #101008 and Unions #101616. This option allows the associated tube to pass completely through the fitting.

# iPolymer TUBE FITTINGS

## Male Elbow

101006

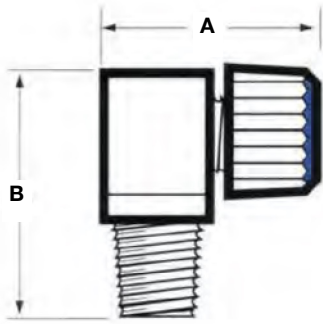

Part #	Tube O.D.	Male Pipe	A Dim.	B Dim.
ME-F-22	1/8"	1/8" NPT	.82	1.01
ME-F-24	1/8"	1/4" NPT	1.06	1.31
ME-F-32	3/16"	1/8" NPT	.82	1.01
ME-F-41	1/4"	1/16" NPT	1.06	1.14
ME-F-42	1/4"	1/8" NPT	1.06	1.14
ME-F-44	1/4"	1/4" NPT	1.06	1.31
ME-F-46	1/4"	3/8" NPT	1.25	1.50
ME-F-52	5/16"	1/8" NPT	1.25	1.31
ME-F-54	5/16"	1/4" NPT	1.25	1.44
ME-F-62	3/8"	1/8" NPT	1.25	1.31
ME-F-64	3/8"	1/4" NPT	1.25	1.50
ME-F-66	3/8"	3/8" NPT	1.25	1.50
ME-F-68	3/8"	1/2" NPT	1.56	1.94
ME-F-86	1/2"	3/8" NPT	1.56	1.94
ME-F-88	1/2"	1/2" NPT	1.56	2.06
ME-F-1212	3/4"	3/4" NPT	1.88	2.31
ME-F-168	1"	1/2" NPT	2.20	2.56
ME-F-1616	1"	1" NPT	2.20	2.75
ME-M-42	4mm	1/8" NPT	.82	1.01
ME-M-62	6mm	1/8" NPT	1.06	1.31
ME-M-64	6mm	1/4" NPT	1.06	1.31
ME-M-84	8mm	1/4" NPT	1.25	1.44
ME-M-104	10mm	1/4" NPT	1.25	1.50
ME-M-106	10mm	3/8" NPT	1.25	1.50

## Male Run Tee

101195

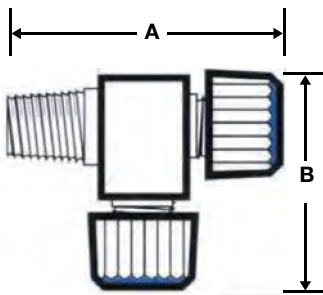

Part #	Tube O.D.	Male Pipe	A Dim.	B Dim.
MRT-F-32	3/16"	1/8" NPT	1.39	.82
MRT-F-41	1/4"	1/16" NPT	1.63	.94
MRT-F-42	1/4"	1/8" NPT	1.63	1.06
MRT-F-44	1/4"	1/4" NPT	1.81	1.06
MRT-F-52	5/16"	1/8" NPT	1.81	1.25
MRT-F-54	5/16"	1/4" NPT	1.94	1.25
MRT-F-64	3/8"	1/4" NPT	2.00	1.25
MRT-F-66	3/8"	3/8" NPT	2.00	1.25
MRT-F-86	1/2"	3/8" NPT	2.31	1.56
MRT-F-88	1/2"	1/2" NPT	2.50	1.56
MRT-F-108	5/8"	1/2" NPT	2.54	1.73
MRT-F-1012	5/8"	3/4" NPT	2.67	1.73
MRT-F-1212	3/4"	3/4" NPT	2.81	1.87
MRT-F-1616	1"	1" NPT	3.33	2.20
MRT-M-42	4mm	1/8" NPT	1.39	.82
MRT-M-62	6mm	1/8" NPT	1.63	1.06
MRT-M-64	6mm	1/4" NPT	1.81	1.06
MRT-M-84	8mm	1/4" NPT	1.94	1.25
MRT-M-104	10mm	1/4" NPT	2.00	1.25
MRT-M-106	10mm	3/8" NPT	2.00	1.25

## Reducing Union

101620

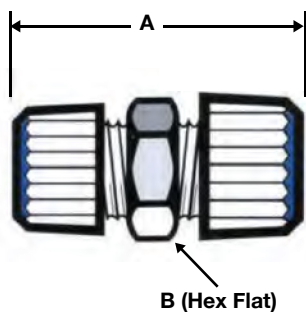

Part #	Tube O.D.	Tube O.D.	A Dim.	B Dim.
RU-F-32	3/16"	1/8"	1.01	.44
RU-F-42	1/4"	1/8"	1.26	.56
RU-F-43	1/4"	3/16"	1.26	.56
RU-F-52	5/16"	1/8"	1.26	.75
RU-F-54	5/16"	1/4"	1.38	.75
RU-F-64	3/8"	1/4"	1.38	.75
RU-F-84	1/2"	1/4"	1.56	.94
RU-F-86	1/2"	3/8"	1.56	.94
RU-F-104	5/8"	1/4"	1.60	1.13
RU-F-106	5/8"	3/8"	1.60	1.13
RU-F-108	5/8"	1/2"	1.66	1.13
RU-F-128	3/4"	1/2"	1.68	1.25
RU-F-1210	3/4"	5/8"	1.72	1.25
RU-F-166	1"	3/8"	1.70	1.50
RU-F-168	1"	1/2"	1.76	1.50
RU-F-1610	1"	5/8"	1.80	1.50
RU-F-1612	1"	3/4"	1.82	1.50
RU-M-46	4mm	6mm	1.26	.56
RU-M-68	6mm	8mm	1.38	.75
RU-M-610	6mm	10mm	1.38	.75
RU-M-810	8mm	10mm	1.38	.75
RU-M-812	8mm	12mm	1.56	.94
RU-M-1012	10mm	12mm	1.56	.94
RU-M-1216	12mm	16mm	1.66	1.13
RU-M-1519	15mm	19mm	1.72	1.25
RU-M-2012	20mm	12mm	1.68	1.25
RU-M-2612	26mm	12mm	1.75	1.50

international polymer solutions inc. • manufacturer of high purity fluid handling products

www.ipolymer.com • info@ipolymer.com

Part #	Tube O.D.	A Dim.	B Dim.
TC-F-2	1/8"	.63	.44
TC-F-3	3/16"	.63	.44
TC-F-4	1/4"	.88	.56
TC-F-5	5/16"	.88	.75
TC-F-6	3/8"	.88	.75
TC-F-8	1/2"	1.06	1.00
TC-F-10	5/8"	1.10	1.13
TC-F-12	3/4"	1.12	1.25
TC-F-16	1"	1.20	1.50

Part #	Tube O.D.	Tube I.D.	A Dim.	B Dim.
TI-F-4	1/4"	3/16"	.50	.19
TI-F-5	5/16"	1/4"	.50	.25
TI-F-6	3/8"	5/16"	.55	.31
TI-F-8	1/2"	7/16"	.75	.44
TI-F-10	5/8"	9/16"	.68	.56
TI-F-12	3/4"	11/16"	.80	.69
TI-F-16	1"	7/8"	.93	.88

Part #	Tube O.D.	A Dim.	B Dim.
U-F-1	1/16"	.44	1.01
U-F-2	1/8"	.44	1.01
U-F-3	3/16"	.44	1.01
U-F-4	1/4"	.56	1.38
U-F-5	5/16"	.75	1.38
U-F-6	3/8"	.75	1.38
U-F-8	1/2"	1.00	1.62
U-F-10	5/8"	1.13	1.70
U-F-12	3/4"	1.25	1.74
U-F-16	1"	1.50	1.90
U-F-1.1	1.1"	1.63	2.12
U-M-4	4mm	.44	1.01
U-M-6	6mm	.56	1.38
U-M-8	8mm	.75	1.38
U-M-10	10mm	.75	1.38
U-M-12	12mm	1.00	1.62

Part #	Tube O.D.	A Dim.
UC-F-2	1/8"	1.20
UC-F-3	3/16"	1.20
UC-F-4	1/4"	1.56
UC-F-5	5/16"	1.75
UC-F-6	3/8"	1.75
UC-F-8	1/2"	2.12
UC-F-10	5/8"	2.33
UC-F-12	3/4"	2.49
UC-F-16	1"	2.90
UC-F-1.1	1.1"	3.25
UC-M-4	4mm	1.20
UC-M-6	6mm	1.56
UC-M-8	8mm	1.75
UC-M-10	10mm	1.75
UC-M-12	12mm	2.12

## Tube Cap

101875

B (Hex Flat)



## Tube Insert

100635

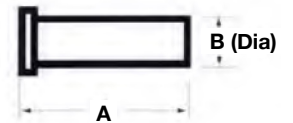

## Union

101616

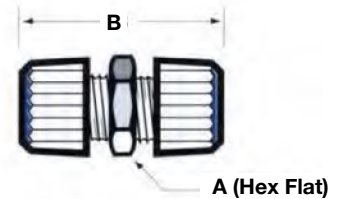

## Union Cross

101610

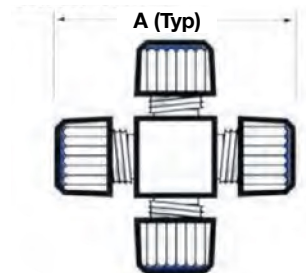



# iPolymer TUBE FITTINGS

## Union Elbow

100870



Part #	Tube O.D.	A Dim.
UE-F-2	1/8"	.82
UE-F-3	3/16"	.82
UE-F-4	1/4"	1.06
UE-F-5	5/16"	1.25
UE-F-6	3/8"	1.25
UE-F-8	1/2"	1.56
UE-F-10	5/8"	1.73
UE-F-12	3/4"	1.87
UE-F-16	1"	2.20
UE-F-1.1	1.1"	2.44
UE-M-4	4mm	.82
UE-M-6	6mm	1.06
UE-M-8	8mm	1.25
UE-M-10	10mm	1.25
UE-M-12	12mm	1.56

## Union Elbow Reducer

101787

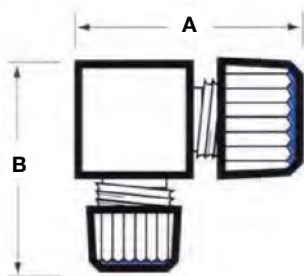

Part #	Tube O.D.	Tube O.D.	A Dim.	B Dim.
UER-F-42	1/4"	1/8"	1.06	1.06
UER-F-64	3/8"	1/4"	1.25	1.25
UER-F-84	1/2"	1/4"	1.56	1.56
UER-F-86	1/2"	3/8"	1.56	1.56
UER-F-108	5/8"	1/2"	1.73	1.73
UER-F-1210	3/4"	5/8"	1.88	1.88
UER-F-1612	1"	3/4"	2.20	2.20
UER-M-84	8mm	4mm	1.25	1.25

## Union Tee

101005

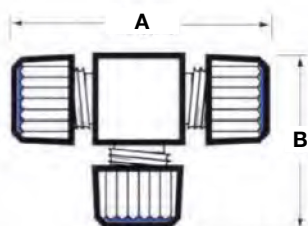

Part #	Tube O.D.	A Dim.	B Dim.
UT-F-2	1/8"	1.20	.82
UT-F-3	3/16"	1.20	.82
UT-F-4	1/4"	1.56	1.06
UT-F-5	5/16"	1.75	1.25
UT-F-6	3/8"	1.75	1.25
UT-F-8	1/2"	2.12	1.56
UT-F-10	5/8"	2.33	1.73
UT-F-12	3/4"	2.50	1.89
UT-F-16	1"	2.90	2.20
UT-F-1.1	1.1"	3.25	2.44
UT-M-4	4mm	1.20	.82
UT-M-6	6mm	1.56	1.06
UT-M-8	8mm	1.75	1.25
UT-M-10	10mm	1.75	1.25
UT-M-12	12mm	2.12	1.56

Part #	Flare	MNPT Size	Orifice	A Dim.	B Dim.
ME-FF-42	1/4"	1/8"	.13	1.56	.95
ME-FF-44	1/4"	1/4"	.13	1.56	1.13
ME-FF-46	1/4"	3/8"	.13	1.56	1.13
ME-FF-64	3/8"	1/4"	.25	1.75	1.31
ME-FF-66	3/8"	3/8"	.25	1.75	1.31
ME-FF-68	3/8"	1/2"	.25	2.10	1.56
ME-FF-86	1/2"	3/8"	.38	2.10	1.56
ME-FF-88	1/2"	1/2"	.38	2.10	1.75
ME-FF-812	1/2"	3/4"	.38	2.35	2.00
ME-FF-128	3/4"	1/2"	.63	2.50	2.00
ME-FF-1212	3/4"	3/4"	.63	2.50	2.00
ME-FF-1216	3/4"	1"	.63	2.60	2.29

## Male Elbow 104590

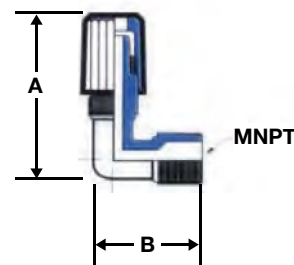

Part #	Flare	FNPT Size	Orifice	A Dim.	B Dim.
FE-FF-42	1/4"	1/8"	.13	1.75	1.13
FE-FF-44	1/4"	1/4"	.13	1.88	1.44
FE-FF-46	1/4"	3/8"	.13	2.00	1.56
FE-FF-64	3/8"	1/4"	.25	1.88	1.44
FE-FF-66	3/8"	3/8"	.25	2.00	1.56
FE-FF-68	3/8"	1/2"	.25	2.25	2.00
FE-FF-86	1/2"	3/8"	.38	2.10	1.56
FE-FF-88	1/2"	1/2"	.38	2.35	2.00

## Female Elbow 108639

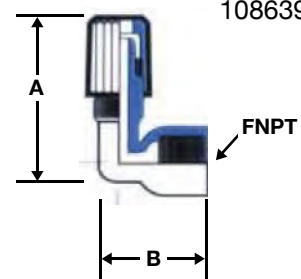

Part #	Flare	Orifice	A Dim.	B Dim.
U-FF-4	1/4"	.13	2.38	0.75
U-FF-6	3/8"	.25	2.38	0.88
U-FF-8	1/2"	.38	2.58	1.00
U-FF-12	3/4"	.63	2.88	1.25
U-FF-16	1"	.88	3.36	1.69

## Union 101621

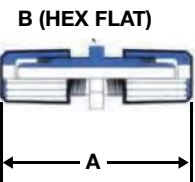

Part #	Flare	Flare	Orifice	A Dim.	B Dim.
RU-FF-64	3/8"	1/4"	.13	2.38	.75
RU-FF-86	1/2"	3/8"	.25	2.60	.94
RU-FF-128	3/4"	1/2"	.38	2.85	1.13

## Reducing Union 106881

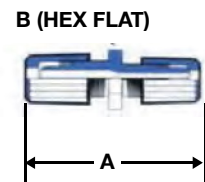

Part #	Flare	Flare	Orifice	A Dim.	B Dim.	C Max	D Hex
BU-FF-4	1/4"	1/4"	.13	3.02	1.65	.50	.56
BU-FF-6	3/8"	3/8"	.25	3.02	1.65	.50	.75
BU-FF-8	1/2"	1/2"	.38	3.12	1.75	.50	.94
BU-FF-12	3/4"	3/4"	.63	3.27	1.90	.50	1.13

## Bulkhead Union 105368

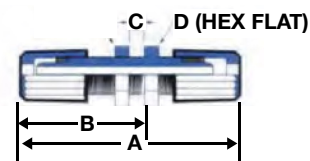

# iPolymer FLARE FITTINGS

## Bulkhead Union Reducer

105368

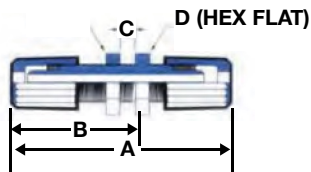

Part #	Flare	Flare	Orifice	A Dim.	B Dim.	C (Max)	D Hex
BUR-FF-64	3/8"	1/4"	.13	3.02	1.65	.50	.75
BUR-FF-86	1/2"	3/8"	.25	3.02	1.75	.50	.94
BUR-FF-128	3/4"	1/2"	.38	3.88	1.90	.50	1.13

## Bulkhead Male Connector

101789

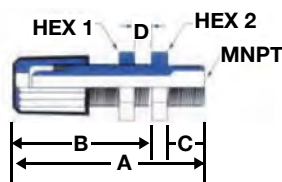

Part #	Flare	MNPT Size	Orifice	A Dim.	B Dim.	C Dim.	D (Max)	Hex 1	Hex 2
BMC-FF-42	1/4"	1/8"	.13	2.67	1.93	.55	.50	3/4	11/16
BMC-FF-44	1/4"	1/4"	.13	2.67	1.93	.55	.50	3/4	11/16
BMC-FF-46	1/4"	3/8"	.13	2.67	1.93	.55	.50	3/4	11/16
BMC-FF-64	3/8"	1/4"	.25	2.79	2.03	.55	.50	15/16	13/16
BMC-FF-66	3/8"	3/8"	.25	2.79	2.03	.55	.50	15/16	13/16
BMC-FF-68	3/8"	1/2"	.25	2.90	2.03	.66	.50	15/16	15/16
BMC-FF-86	1/2"	3/8"	.38	2.91	2.13	.55	.50	1-1/16	15/16
BMC-FF-88	1/2"	1/2"	.38	3.02	2.13	.66	.50	1-1/16	15/16
BMC-FF-812	1/2"	3/4"	.38	3.03	2.13	.67	.50	1-1/16	1-3/16
BMC-FF-128	3/4"	1/2"	.63	3.19	2.28	.66	.50	1-5/16	1-3/16
BMC-FF-1212	3/4"	3/4"	.63	3.20	2.25	.67	.50	1-5/16	1-3/16

## Union Tee

104591

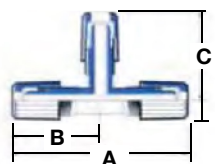

Part #	Flare	Orifice	A Dim.	B Dim.	C Dim.
UT-FF-4	1/4"	.13	2.56	1.28	1.56
UT-FF-6	3/8"	.25	2.75	1.38	1.75
UT-FF-8	1/2"	.38	3.20	1.60	2.10
UT-FF-12	3/4"	.63	3.75	1.88	2.50

## Male Branch Tee

104609

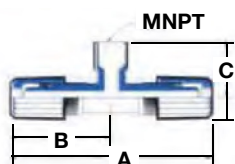

Part #	Flare	MNPT Size	Orifice	A Dim.	B Dim.	C Dim.
MBT-FF-44	1/4"	1/4"	.13	2.56	1.28	1.12
MBT-FF-66	3/8"	3/8"	.25	2.75	1.38	1.31
MBT-FF-88	1/2"	1/2"	.38	3.20	1.60	1.75
MBT-FF-1212	3/4"	3/4"	.63	3.75	1.88	2.00

## Male Run Tee

101197

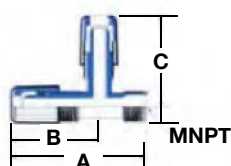

Part #	Flare	MNPT Size	Orifice	A Dim.	B Dim.	C Dim.
MRT-FF-44	1/4"	1/4"	.13	2.12	1.28	1.56
MRT-FF-66	3/8"	3/8"	.25	2.31	1.38	1.75
MRT-FF-88	1/2"	1/2"	.38	2.85	1.60	2.10
MRT-FF-1212	3/4"	3/4"	.63	3.25	1.88	2.50

Part #	Flare	Orifice	A Dim.
UE-FF-4	1/4"	.13	1.56
UE-FF-6	3/8"	.25	1.75
UE-FF-8	1/2"	.38	2.10
UE-FF-12	3/4"	.63	2.50
UE-FF-16	1"	.88	2.99

Part #	Flare	Flare	Orifice	A Dim.	B Dim.
UER-FF-64	3/8"	1/4"	.125	1.88	1.88
UER-FF-66	3/8"	3/8"	.25	1.88	1.88
UER-FF-128	3/4"	1/2"	.38	2.50	2.35
UER-FF-1612	1"	3/4"	.63	2.99	2.75

Part #	Flare	MNPT Size	Orifice	A Dim.	B Dim.
MC-FF-42	1/4"	1/8"	.13	1.76	.56
MC-FF-44	1/4"	1/4"	.13	1.94	.56
MC-FF-46	1/4"	3/8"	.13	2.06	.75
MC-FF-64	3/8"	1/4"	.25	1.94	.75
MC-FF-66	3/8"	3/8"	.25	1.94	.75
MC-FF-68	3/8"	1/2"	.25	2.25	.94
MC-FF-86	1/2"	3/8"	.38	2.16	.94
MC-FF-88	1/2"	1/2"	.39	2.35	.94
MC-FF-812	1/2"	3/4"	.38	2.35	1.13
MC-FF-128	3/4"	1/2"	.55	2.50	1.13
MC-FF-1212	3/4"	3/4"	.63	2.50	1.13
MC-FF-1216	3/4"	1"	.88	2.69	1.50

Part #	Flare	FNPT Size	Orifice	A Dim.	B Dim.
FC-FF-42	1/4"	1/8"	.13	1.76	.75
FC-FF-44	1/4"	1/4"	.13	1.94	.84
FC-FF-46	1/4"	3/8"	.13	1.94	1.00
FC-FF-64	3/8"	1/4"	.25	1.94	.84
FC-FF-66	3/8"	3/8"	.25	1.94	1.00
FC-FF-68	3/8"	1/2"	.25	2.13	1.25
FC-FF-86	1/2"	3/8"	.38	2.04	1.00
FC-FF-88	1/2"	1/2"	.38	2.23	1.25
FC-FF-812	1/2"	3/4"	.38	2.23	1.50
FC-FF-128	3/4"	1/2"	.63	2.38	1.25
FC-FF-1212	3/4"	3/4"	.63	2.38	1.50

Part #	Flare	A Dim.	Orifice
N-FF-4	1/4"	1.05	.26
N-FF-6	3/8"	1.05	.38
N-FF-8	1/2"	1.13	.51
N-FF-12	3/4"	1.30	.76
N-FF-16	1"	1.50	1.01

Part #	Flare	A Dim.	B Dim.
FCAP-4	1/4"	1.06	0.75
FCAP-6	3/8"	1.13	0.88
FCAP-8	1/2"	1.13	1.00
FCAP-12	3/4"	1.28	1.38
FCAP-16	1"	1.51	1.75

## Union Elbow

108000

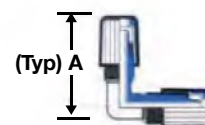

## Union Elbow Reducer

108877

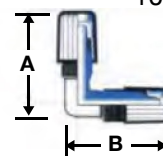

## Male Connector

104950

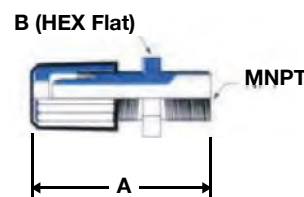

## Female Connector

108586

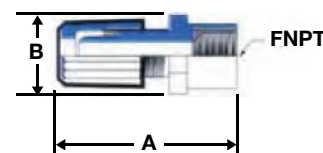

## Flare Nut

103350

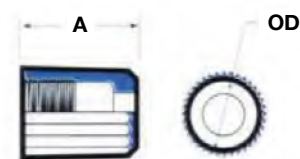

## Flare Cap

111630

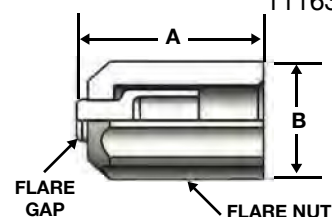

# iPolymer PIPE FITTINGS

## Bushing

100640

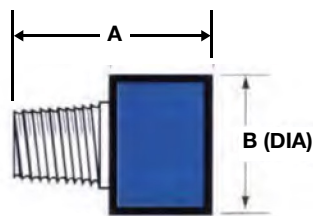

Part #	Male Pipe	Female Pipe	A Dim.	B Dim.
B-P-42	1/4" NPT	1/8" NPT	1.32	.75
B-P-44	1/4" NPT	1/4" NPT	1.50	.84
B-P-46	1/4" NPT	3/8" NPT	1.50	1.00
B-P-64	3/8" NPT	1/4" NPT	1.50	.84
B-P-68	3/8" NPT	1/2" NPT	1.69	1.25
B-P-84	1/2" NPT	1/4" NPT	1.81	.88
B-P-86	1/2" NPT	3/8" NPT	1.81	1.00
B-P-124	3/4" NPT	1/4" NPT	1.81	1.13
B-P-128	3/4" NPT	1/2" NPT	2.00	1.25
B-P-1212	3/4" NPT	3/4" NPT	2.00	1.50
B-P-168	1" NPT	1/2" NPT	2.19	1.38
B-P-1612	1" NPT	3/4" NPT	2.19	1.50

## Short Bushing

103187

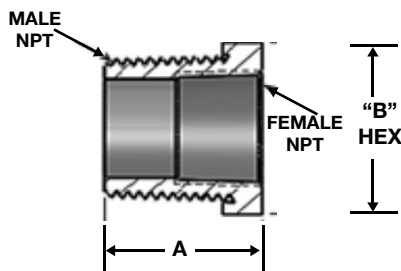

Part #	Male Pipe	Female Pipe	A Dim.	B Dim.
SB-P-42	1/4" NPT	1/8" NPT	0.94	0.63
SB-P-62	3/8" NPT	1/8" NPT	1.00	0.75
SB-P-64	3/8" NPT	1/4" NPT	1.00	0.88
SB-P-82	1/2" NPT	1/8" NPT	1.00	0.94
SB-P-84	1/2" NPT	1/4" NPT	1.00	0.94
SB-P-86	1/2" NPT	3/8" NPT	1.00	0.94
SB-P-124	3/4" NPT	1/4" NPT	1.00	1.25
SB-P-126	3/4" NPT	3/8" NPT	1.00	1.25
SB-P-128	3/4" NPT	1/2" NPT	1.26	1.25
SB-P-164	1" NPT	1/4" NPT	1.45	1.50
SB-P-166	1" NPT	3/8" NPT	1.45	1.50
SB-P-168	1" NPT	1/2" NPT	1.45	1.50
SB-P-1612	1" NPT	3/4" NPT	1.45	1.50

## Coupling

101617

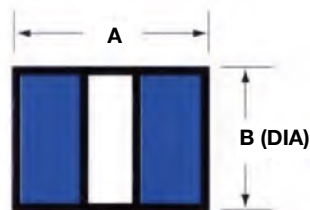

Part #	Female Pipe	A Dim.	B Dim.
C-P-2	1/8" NPT	1.06	.75
C-P-4	1/4" NPT	1.56	.84
C-P-6	3/8" NPT	1.56	.88
C-P-8	1/2" NPT	2.06	1.13
C-P-12	3/4" NPT	2.06	1.50
C-P-16	1" NPT	2.50	1.75

## Elbow

101196

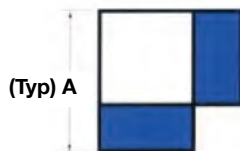

Part #	Female Pipe	A Dim.
E-P-2	1/8" NPT	1.13
E-P-4	1/4" NPT	1.40
E-P-6	3/8" NPT	1.56
E-P-8	1/2" NPT	2.00
E-P-12	3/4" NPT	2.25
E-P-16	1" NPT	2.69
E-P-24	1.5" NPT	3.50

## Pipe Nipple

101618

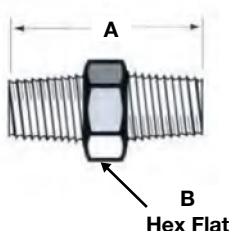

Part #	Male Pipe	A Dim.	B Dim.
NP-P-2	1/8" NPT	1.01	.44
NP-P-4	1/4" NPT	1.50	.56
NP-P-6	3/8" NPT	1.50	.75
NP-P-8	1/2" NPT	2.00	.94
NP-P-12	3/4" NPT	2.00	1.25
NP-P-16	1" NPT	2.38	1.50

iPolymer supplies custom extended length Pipe Nipples (NP-P-XX-XXX defining the overall pipe length). Custom lengths up to 18" can be supplied. These are supplied in 1/16" increments. 1" is represented as 16. 2" is represented as 32. 12" is represented as 192.

Female Pipe Cross

112065

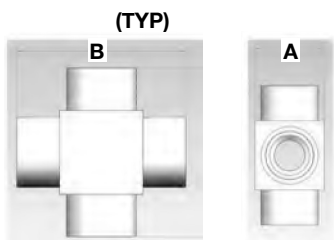

Part #	Female Pipe	A Dim.	B Dim.
FPC-P-2	1/8" NPT	.75	1.51
FPC-P- 4	1/4" NPT	.85	1.94
FPC-P-6	3/8" NPT	1.00	2.12
FPC-P-8	1/2" NPT	1.25	2.75
FPC-P-12	3/4" NPT	1.50	2.95
FPC-P-16	1" NPT	1.75	3.63

Female Pipe Cap

112066

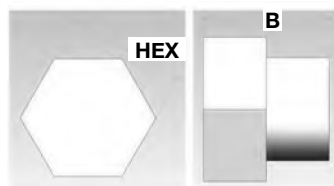

Part #	Female Pipe	Hex	B DIM.
PC-P-1	1/16" NPT	3/4	.68
PC-P-2	1/8" NPT	7/8	.76
PC-P-4	1/4" NPT	1	.94
PC-P-6	3/8" NPT	1-1/8	.94
PC-P-8	1/2" NPT	1-3/8	1.25
PC-P-12	3/4" NPT	1-1/2	1.25
PC-P-16	1" NPT	1-3/4	1.44
PC-P-20	1-1/4" NPT	2-1/4	1.63
PC-P-24	1-1/2" NPT	2-3/8	1.63
PC-P-32	2" NPT	3	1.69

Nipple Pipe Reducer

112067

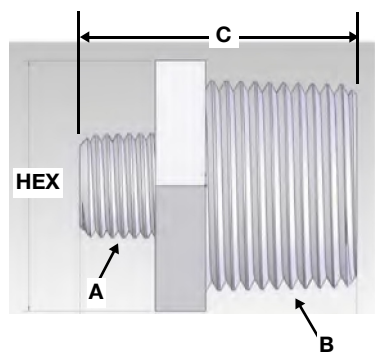

Part #	"A" Pipe	"B" Pipe	Hex	C Dim.
NPR-P-24	1/8" NPT	1/4" NPT	9/16	1.32
NPR-P-26	1/8" NPT	3/8" NPT	7/8	1.32
NPR-P-28	1/8" NPT	1/2" NPT	15/16	1.63
NPR-P-212	1/8" NPT	3/4" NPT	1-1/4	1.63
NPR-P-216	1/8" NPT	1" NPT	1-1/2	1.82
NPR-P-46	1/4" NPT	3/8" NPT	7/8	1.50
NPR-P-48	1/4" NPT	1/2" NPT	15/16	1.81
NPR-P-412	1/4" NPT	3/4" NPT	1-1/4	1.81
NPR-P-416	1/4 " NPT	1" NPT	1-1/2	2.00
NPR-P-68	3/8" NPT	1/2" NPT	15/16	1.81
NPR-P-612	3/8" NPT	3/4" NPT	1-1/4	1.81
NPR-P-616	3/8" NPT	1" NPT	1-1/2	2.00
NPR-P-812	1/2 " NPT	3/4" NPT	1-1/4	2.00
NPR-P-816	1/2" NPT	1" NPT	1-1/2	2.19
NPR-P-1216	3/4" NPT	1" NPT	1-1/2	2.19

# iPolymer PIPE FITTINGS

## Female Reducer

101775

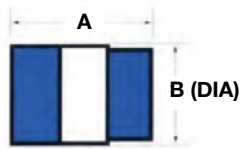

Part #	Female Pipe	Female Pipe	A Dim.	B Dim.
FR-P-42	1/4" NPT	1/8" NPT	1.32	.84
FR-P-62	3/8" NPT	1/8" NPT	1.32	1.00
FR-P-64	3/8" NPT	1/4" NPT	1.50	1.00
FR-P-84	1/2" NPT	1/4" NPT	1.81	1.25
FR-P-86	1/2" NPT	3/8" NPT	1.81	1.25
FR-P-128	3/4" NPT	1/2" NPT	2.00	1.50
FR-P-168	1" NPT	1/2" NPT	2.19	1.75
FR-P-1612	1" NPT	3/4" NPT	2.19	1.75

## Pipe Union

103790

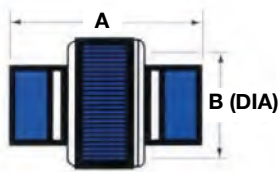

Part #	Female Pipe	A Dim.	B Dim.
PU-P-2	1/8 NPT	1.60	1.25
PU-P-4	1/4 NPT	2.05	1.50
PU-P-6	3/8 NPT	2.13	1.75
PU-P-8	1/2 NPT	2.51	1.75
PU-P-12	3/4 NPT	2.90	2.25
PU-P-16	1" NPT	3.43	2.69

## Plug

101780

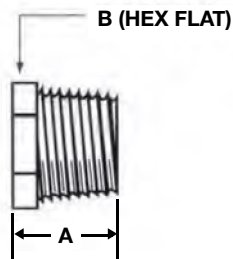

Part #	Male Pipe	A Dim.	B Dim.
P-P-1	1/16" NPT	.63	.38
P-P-2	1/8" NPT	.63	.44
P-P-4	1/4" NPT	.94	.56
P-P-6	3/8" NPT	.94	.75
P-P-8	1/2" NPT	1.25	.94
P-P-12	3/4" NPT	1.25	1.25
P-P-16	1" NPT	1.44	1.50
P-P-24	1.5" NPT	1.50	2.00

## Tee

101782

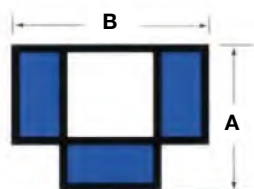

Part #	Female Pipe	A Dim.	B Dim.
T-P-2	1/8" NPT	1.13	1.51
T-P-4	1/4" NPT	1.44	2.00
T-P-6	3/8" NPT	1.56	2.12
T-P-8	1/2" NPT	2.00	2.75
T-P-12	3/4" NPT	2.25	3.00
T-P-16	1" NPT	2.69	3.63

Part #	Male Pipe	Female Pipe	A Dim.	B Dim.	C Dim.
SE-P-1	1/16" NPT	1/16" NPT	.63	1.32	1.13
SE-P-2	1/8" NPT	1/8" NPT	.75	1.32	1.13
SE-P-4	1/4" NPT	1/4" NPT	.84	1.63	1.44
SE-P-6	3/8" NPT	3/8" NPT	1.00	1.94	1.56
SE-P-8	1/2" NPT	1/2" NPT	1.25	2.19	2.00
SE-P-12	3/4" NPT	3/4" NPT	1.50	2.44	2.25
SE-P-16	1" NPT	1" NPT	1.75	2.88	2.44

## Street Elbow

104138

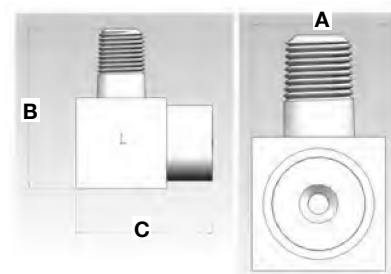

Part #	Male Pipe	Female Pipe	A Dim.	B Dim.	C Dim.
SER-P-24	1/8" NPT	1/4" NPT	.88	1.45	1.44
SER-P-26	1/8" NPT	3/8" NPT	1.00	1.57	1.56
SER-P-28	1/8" NPT	1/2" NPT	1.25	1.82	2.00
SER-P-212	1/8" NPT	3/4" NPT	1.50	2.07	2.25
SER-P-216	1/8" NPT	1" NPT	1.75	2.32	2.69
SER-P-42	1/4" NPT	1/8" NPT	.75	1.50	1.13
SER-P-46	1/4" NPT	3/8" NPT	1.00	1.75	1.56
SER-P-48	1/4" NPT	1/2" NPT	1.25	2.00	2.00
SER-P-412	1/4" NPT	3/4" NPT	1.50	2.25	2.25
SER-P-416	1/4" NPT	1" NPT	1.75	2.50	2.69
SER-P-62	3/8" NPT	1/8" NPT	.75	1.50	1.13
SER-P-64	3/8" NPT	1/4" NPT	.88	1.63	1.44
SER-P-68	3/8" NPT	1/2" NPT	1.25	2.00	2.00
SER-P-612	3/8" NPT	3/4" NPT	1.50	2.25	2.25
SER-P-616	3/8" NPT	1" NPT	1.75	2.50	2.69
SER-P-82	1/2" NPT	1/8" NPT	1.00	1.94	1.38
SER-P-84	1/2" NPT	1/4" NPT	1.00	1.94	1.56
SER-P-86	1/2" NPT	3/8" NPT	1.00	1.94	1.56
SER-P-812	1/2" NPT	3/4" NPT	1.50	2.40	2.25
SER-P-816	1/2" NPT	1" NPT	1.75	2.69	2.69
SER-P-122	3/4" NPT	1/8" NPT	1.50	2.44	1.88
SER-P-124	3/4" NPT	1/4" NPT	1.50	2.44	2.06
SER-P-126	3/4" NPT	3/8" NPT	1.50	2.44	2.06
SER-P-128	3/4" NPT	1/2" NPT	1.50	2.44	2.25
SER-P-1216	3/4" NPT	1" NPT	1.75	2.69	2.69
SER-P-162	1" NPT	1/8" NPT	1.50	2.63	1.88
SER-P-164	1" NPT	1/4" NPT	1.50	2.63	2.06
SER-P-166	1" NPT	3/8" NPT	1.50	2.63	2.06
SER-P-168	1" NPT	1/2" NPT	1.50	2.63	2.25
SER-P-1612	1" NPT	3/4" NPT	1.50	2.63	2.25

## Street Elbow Reducer

112069

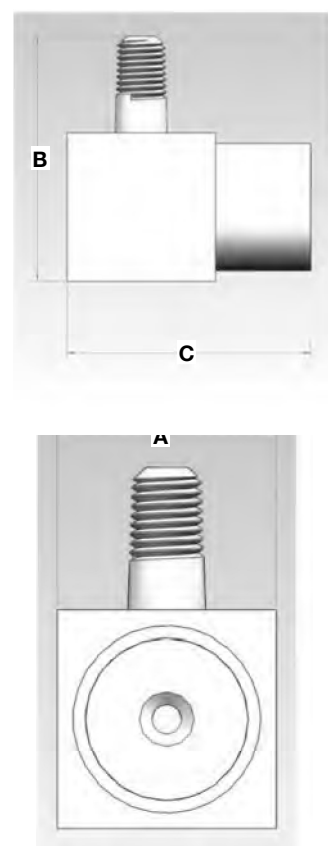



# iPolymer PIPE FITTINGS

## Male Pipe Elbow

112070

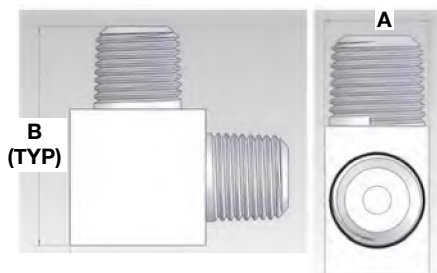

Part #	Male Pipe	A Dim.	B Dim.
ME-P-1	1/16" NPT	.44	1.01
ME-P-2	1/8" NPT	.44	1.01
ME-P-4	1/4" NPT	.56	1.31
ME-P-6	3/8" NPT	.75	1.50
ME-P-8	1/2" NPT	1.00	1.94
ME-P-12	3/4" NPT	1.25	2.19
ME-P-16	1" NPT	1.50	2.63

## Male Pipe Reducing Elbow

112071

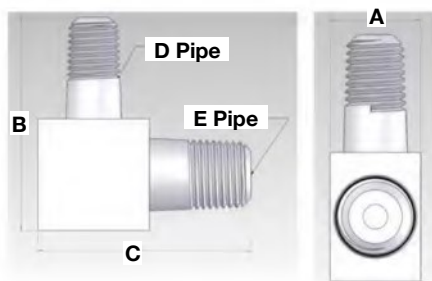

Part #	"D" Pipe	"E" Pipe	A Dim.	B Dim.	C Dim.
MPRE-P-12	1/16" NPT	1/8" NPT	.44	1.01	1.01
MPRE-P-24	1/8" NPT	1/4" NPT	.56	1.13	1.31
MPRE-P-26	1/8" NPT	3/8" NPT	.75	1.32	1.50
MPRE-P-28	1/8" NPT	1/2" NPT	1.00	1.57	1.94
MPRE-P-212	1/8" NPT	3/4" NPT	1.25	1.82	2.19
MPRE-P-216	1/8" NPT	1" NPT	1.50	2.07	2.63
MPRE-P-46	1/4" NPT	3/8" NPT	.75	1.50	1.50
MPRE-P-48	1/4" NPT	1/2" NPT	1.00	1.75	1.94
MPRE-P-412	1/4" NPT	3/4" NPT	1.25	2.00	2.19
MPRE-P-416	1/4" NPT	1" NPT	1.50	2.25	2.63
MPRE-P-68	3/8" NPT	1/2" NPT	1.00	1.75	1.94
MPRE-P-612	3/8" NPT	3/4" NPT	1.25	2.00	2.19
MPRE-P-616	3/8" NPT	1" NPT	1.50	2.25	2.63
MPRE-P-812	1/2" NPT	3/4" NPT	1.25	2.19	2.19
MPRE-P-816	1/2" NPT	1" NPT	1.50	2.44	2.63
MPRE-P-1216	3/4" NPT	1" NPT	1.50	2.44	2.63

## Male Pipe Tee

112068

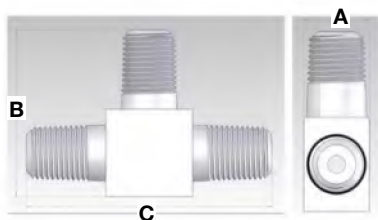

Part #	Male Pipe	A Dim.	B Dim.	C Dim.
MPT-1	1/16" NPT	.44	1.01	1.58
MPT-2	1/8" NPT	.44	1.01	1.58
MPT-4	1/4" NPT	.56	1.31	2.06
MPT-6	3/8" NPT	.75	1.50	2.25
MPT-8	1/2" NPT	1.00	1.94	2.88
MPT-12	3/4" NPT	1.25	2.19	3.13
MPT-16	1" NPT	1.50	2.63	3.76

Plumber Ferrule P/N	Ferrule Gripper P/N	Tempress Ferrule P/N	Tube O.D.
PF-F-1	N/A	N/A	1/16"
PF-F-2	FG-F-2	N/A	1/8"
PF-F-3	FG-F-3	N/A	3/16"
PF-F-4	FG-F-4	TF-F-4	1/4"
PF-F-5	FG-F-5	TF-F-5	5/16"
PF-F-6	FG-F-6	TF-F-6	3/8"
PF-F-8	FG-F-8	TF-F-8	1/2"
PF-F-10	FG-F-10	TF-F-10	5/8"
PF-F-12	FG-F-12	TF-F-12	3/4"
PF-F-16	FG-F-16	TF-F-16	1"
PF-F-11	FG-F-11	TF-F-11	1.1"
PF-F-22	FG-F-22	TF-F-22	1-3/8"
PF-M-4	FG-M-4	TF-M-4	4mm
PF-M-6	FG-M-6	TF-M-6	6mm
PF-M-7	FG-M-7	TF-M-7	7mm
PF-M-8	FG-M-8	TF-M-8	8mm
PF-M-9	FG-M-9	TF-M-9	9mm
PF-M-10	FG-M-10	TF-M-10	10mm
PF-M-12	FG-M-12	TF-M-12	12mm
PF-M-15	FG-M-15	TF-M-15	15mm
PF-M-20	FG-M-20	TF-M-20	20mm
PF-M-26	FG-M-26	TF-M-26	26mm

## Plumber Ferrule (PF)

100426



## Ferrule Gripper (FG)

112090

Two Piece Set

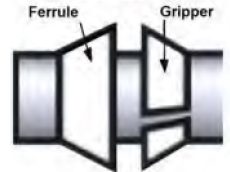

## Tempress Ferrule (TF)

101661

One Piece Snap-In Type.  
for use with -TA & -TS  
Teflon Nuts Only



Part #	Tube O.D.	Thread Size	A Dim. (Max)	B Dim. (Max)
N-F-1	1/16"	1/4-28	.61	.50
N-F-2	1/8"	5/16-24	.61	.50
N-F-3	3/16"	3/8-24	.61	.59
N-F-4	1/4"	7/16-20	.61	.68
N-F-5	5/16"	9/16-18	.64	.78
N-F-6	3/8"	1-1/16-16	.64	.88
N-F-8	1/2"	7/8-14	.73	1.25
N-F-10	5/8"	1-12	.77	1.38
N-F-12	3/4"	1-1/8-12	.82	1.50
N-F-16	.1"	1-3/8-12	.90	1.75
N-F-1.1	1.1"	1-1/2-12	1.04	1.88
N-F-22	1-3/8"	1-3/4-12	1.29	2.25
N-M-4	4mm	3/8-24	.61	.59
N-M-6	6mm	7/16-20	.61	.66
N-M-7	7mm	7/16-20	.61	.66
N-M-8	8mm	9/16-18	.64	.88
N-M-9	9mm	11/16-16	.64	.88
N-M-10	10mm	11/16-16	.64	.91
N-M-12	12mm	7/8-14	.73	1.16
N-M-15	15mm	1-12	.77	1.38
N-M-20	20mm	1-1/8-12	.82	1.50
N-M-26	26mm	1-1/2-12	1.04	1.88

Part #	Thread Size	A Dim.	B Dim.
PN-F-1	5/16-24	.50	.25
PN-F-2	3/8-24	.56	.25
PN-F-3	7/16-20	.69	.25
PN-F-4	9/16-18	.88	.25
PN-F-5	1-1/16-16	.94	.28
PN-F-6	7/8-14	1.31	.31
PN-F-7	1-12	1.25	.31
PN-F-8	1-1/8-12	1.38	.31
PN-F-9	1-3/8-12	1.75	.31
PN-F-10	1-1/2-12	2.00	.31
PN-F-11	1-5/8-12	2.12	.31
PN-F-12	1-3/4-12	2.25	.31
PN-F-18	1-7/8-12	2.38	.31

## Tube Nut

101966 / 111722 / 103202

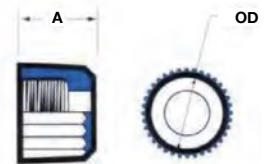

## TA & TS PTFE Tube Nut Style

101615

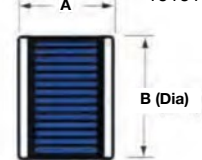

## Panel Nut

100162



112091

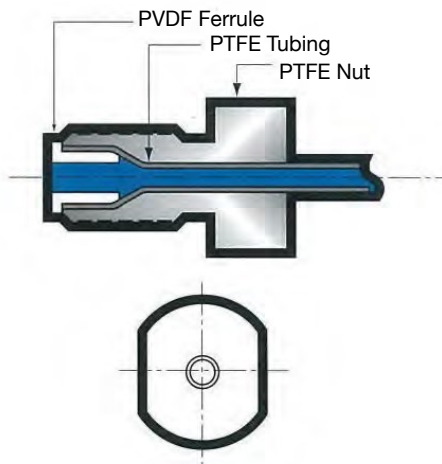

Part #	Tube O.D.	Tube I.D.	Tube Wall	Recommended Tubing	Thread Size
TN062016	.063"	.031"	.016"	FEP-062-016 or FT-062-016	1/4" - 28
TN125016	.125"	.093"	.016"	FEP-125-016 or FT-125-016	1/4" - 28
TN125030	.125"	.065"	.030"	FEP-125-030 or FT-125-030	1/4" - 28
KF062016	.063"	.031"	.016"	FEP-062-016 or FT-062-016	n/a
KF125016	.125"	.093"	.016"	FEP-125-016 or FT-125-016	n/a
KF125030	.125"	.065"	.030"	FEP-125-030 or FT-125-030	n/a

Part #	Tube O.D.	Tube I.D.	Tube Wall	Construction
ITMTF-A		.031"		1 pc metal
ITMTF-B		.093"		1 pc metal
ITMTF-C		.065"		1 pc metal

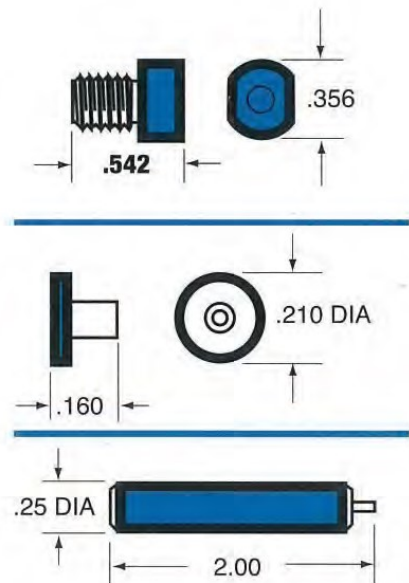

These small High-Purity PTFE Fittings are designed to mate with 1/32", 2/32" and 3/32" I.D. precision tube.

### Common Applications:

- Gas & Liquid Analysis
- Precision Chemical Dosing
- Chromatography Stations
- Analytical Reagenting Blending
- Calibration Standard Sampling

**Call us with your Special Applications.**

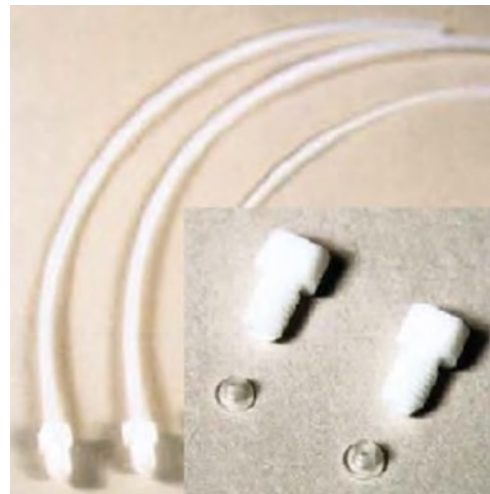

Free flowing orifices through fittings and valve ports are defined by the standard port connection callout.

Female NPT (FNPT) & Male NPT (MNPT) ports flow with a maximum orifice equal to the port callout.

Compression Tube and Flared Connections have smaller flow orifices as listed in the table to the right.

*For custom solutions, smaller orifices are available on request.*

Typical Orifice Per Port Size & Type

Port Size	Pipe Port	Tube Port	Flare Port
1/16"	0.062	0.031	-
1/8"	0.125	0.063	-
1/4"	0.250	0.188	0.125
3/8"	0.375	0.312	0.250
1/2"	0.500	0.436	0.375
3/4"	0.750	0.688	0.592
1"	1.000	0.938	0.875

For standard PTFE Fittings & Connectors and Schedule 80 Pipe, the curves to the right represent working pressure versus media temperature (at soaked steady state).

**Pressure:**

- 100 psi = 6.89 bar
- 75 psi = 5.17 bar
- 50 psi = 3.44 bar
- 25 psi = 1.72 bar

**Temperature:**

- 70°F = 21.1°C
- 100°F = 37.8°C
- 200°F = 93.3°C
- 300°F = 148.9°C
- 400°F = 204.4°C

Pressure Ratings  
PTFE FNPT & MNPT Fittings & Connectors & Schedule 80 Pipe

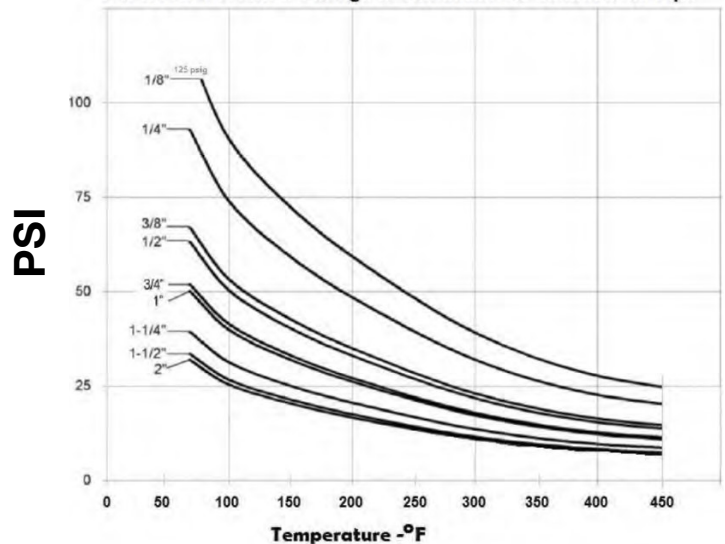

Polytetrafluoroethylene; PTFE Tape (also known as Teflon Tape, Thread Seal Tape or Plumber’s Tape) is recommended for all NPT Connections. This thin film of tape is wrapped around the pipe threads per the manufacturer’s specifications.



Polytetrafluoroethylene (PTFE) Fittings & Connectors are commonly used for Ultra Purity or Highly Caustic Media. While exceptionally inert, excellent with numerous chemistries and temperature extremes, PTFE is a relatively soft fluoropolymer material.

Care must be taken not to over tighten and strip threaded PTFE Connections. PTFE Tape will help reduce thread damage when adapting metal & PTFE connections.